

SINGLE-PHASE CONNECTIONS (ONE-ELEMENT)

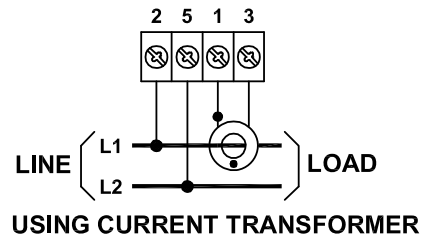

THREE-PHASE, THREE-WIRE CONNECTIONS (TWO-ELEMENT)

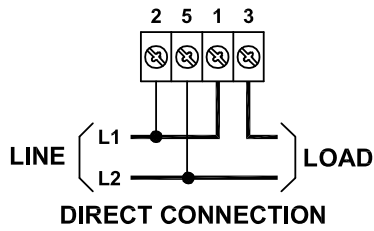
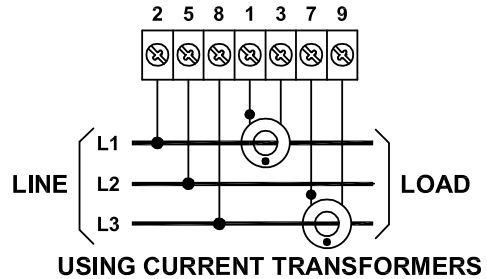
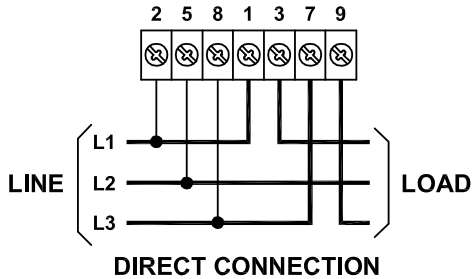

THREE-PHASE, FOUR-WIRE CONNECTIONS (THREE-ELEMENT)

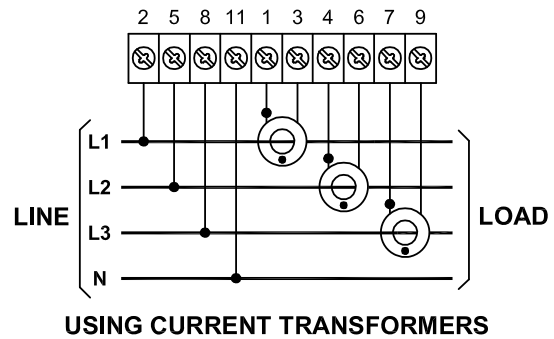
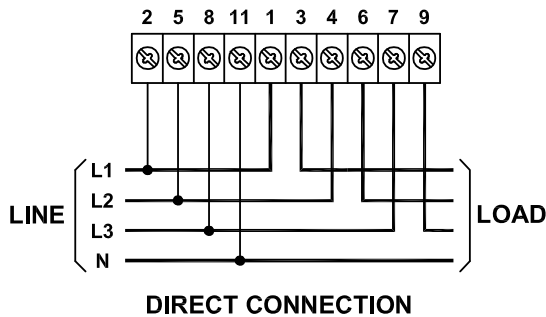

CASE DIMENSIONS

SINGLE-PHASE MODELS

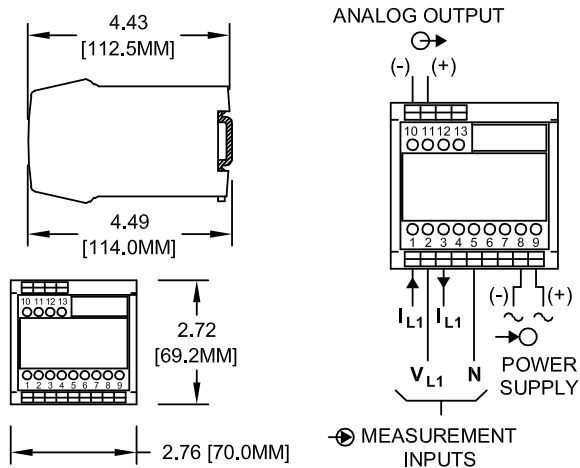

THREE-PHASE MODELS

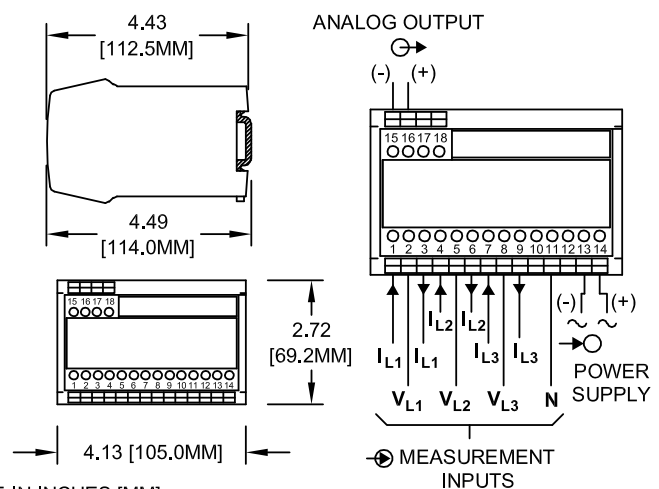

1. DIMENSIONS ARE IN INCHES [MM].
2. MOUNTED ON 35MM TOP-HAT DIN-RAIL.

Dwg # 0902-00876-B Rev --