

RPS50

MULTISCALE ROGOWSKI COIL ADAPTER

USER'S MANUAL



OHIO SEMITRONICS, INC.
4242 Reynolds Drive
Hilliard, Ohio 43026
Telephone: 614-777-1005
Toll Free: 800-537-6732
FAX: 614-777-4511
e-mail: info@ohiosemitronics.com
www.ohiosemitronics.com



1. INTRODUCTION

This manual provides information on the proper installation, configuration and use of the adapter functions. The manual is not intended for general users, but for qualified, professional and skilled technicians, authorised to act in accordance with the safety standards relating to the dangers posed by electric current. This person must have appropriate training and wear suitable Personal Protective Equipment.



WARNING!

It is strictly forbidden for anyone who does not fulfil the above-mentioned requirements to install or use the adapter.

It is forbidden to use the adapter for purposes other than intended ones. The information herein contained shall not be shared with third parties. Any duplication of this manual, either partial or total, not authorised in writing by the Manufacturer and obtained by photocopying, duplicating or using any other electronic means, violates the terms of copyright and is punishable by law.

Any brand in the publication belongs to the legitimate registered owners.



The device complies with European standards 89/336/EEC, 73/23/EEC and their following updating.

2. GRAPHIC SYMBOLS

Some instructions in the manual and on the device are highlighted by graphic symbols to draw the reader's attention to the operational dangers. The following graphic symbols are used:



WARNING!

This warning indicates the possible occurrence of an event which may cause a serious accident or considerable damage to the device if suitable precautionary countermeasures are not taken.



NOTE

This warning indicates important information which must be read carefully.

3. DESCRIPTION

The RPS50 is a multiscale Rogowski coil integrator, powered directly from the mains. An integrator is essential to equalize and shift by 90° the output signal from the Rogowski coils. It consists of an active electronic circuit with negligible offset and good linearity.

The RPS50 can be used with either GPC80 or MFC150 series coils, both rigid and flexible. The module is available in the standard configuration with one of the following 3 fullscales: 0.5, 2.5, 10kA; or 2.5, 10, 50kA; or 10, 50, 250kA.

On request, the input value and the output full scale can be customized according to the application.

The RPS50 with a Rogowski current transducer is a very flexible system, suitable for high-power load analysis, impulse current monitoring, DC ripple measurement, etc.

Due to their specific features, flexible Rogowski coils are an extremely convenient solution for current measurement and can be used in a number of cases where traditional current transducers are not an adequate solution.

4. PRELIMINARY VERIFICATION



NOTE

When opening the box, check that the instrument has not been damaged during transport. If the instrument appears to be damaged, contact the sales representative.

The box contains:

- the integrator
- a calibration resistance
- the user's manual

5. INSTALLATION



NOTE

The equipment complies with the 89/366/EEC, 73/23/EEC standards and following amendments. However, if not properly installed, it may generate a magnetic field and radio interference.

5.1 ENVIRONMENTAL REQUIREMENTS

The environment in which the instrument is installed must satisfy the following features:

- no vibrations
- indoor area
- temperature between -10°C and +50°C (+14°F and +122°F)
- storage between -25°C and +70°C (-13°F and +158°F)
- max. humidity 80% (no condensation)



NOTE

The instrument must not be exposed to sunlight.

5.2 MOUNTING

The instrument is designed for use on DIN EN 50022 rail.

To mount the instrument on DIN rail, follow the description below:

- Hang the device from the top of the DIN rail with the metal hook facing down.
- Pull the instrument downward and against the DIN rail until it snaps in place. The instrument will now be fastened to the DIN rail.
- To remove the instrument, use a screwdriver, as a lever, on the metal hook at the base of the instrument.

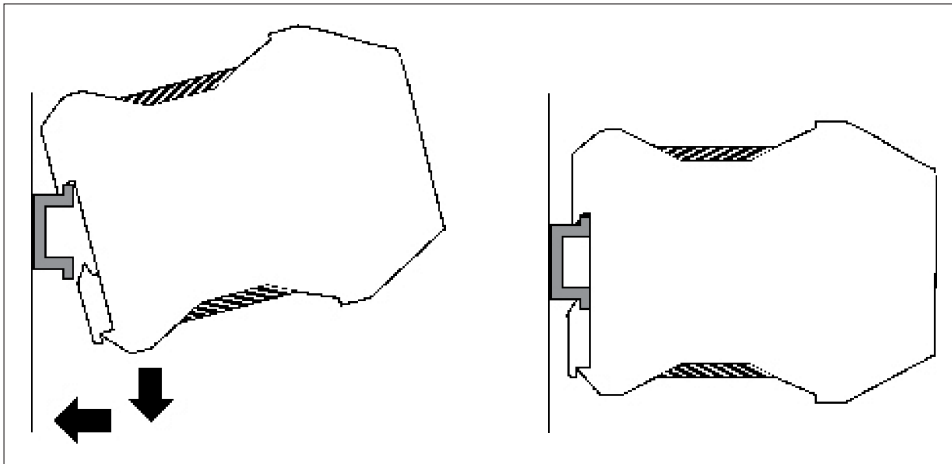
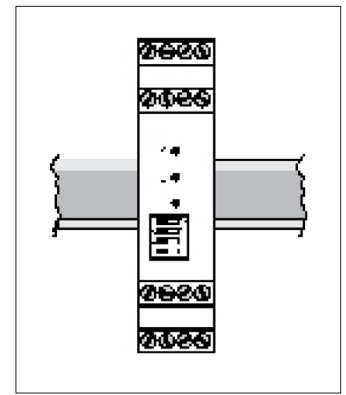

6. SAFETY MEASURES & ELECTRICAL CONNECTIONS



WARNING!

Electrical instrument connections must be carried out only by qualified technicians aware of the risks involved in the presence of voltage.



WARNING!

Before making any connection, check that the device is NOT POWERED.



NOTE: There are several possible coil wire configurations:

Coil Config.	Coil Output (RPS Input)	Ground	Shield
1	Brown	Blue or White	Black or none
2	White	Black	none
3	Red	Black	none

Before connecting, check the following:

1. the conductor wires are not powered.
2. the power supply corresponds to the values on the instrument label.
3. the instrument has been installed in a vibration-free and a suitable temperature environment (see section 5.1).
4. the wiring is carried out in accordance with all standards in force in the country where the instrument is to be installed.

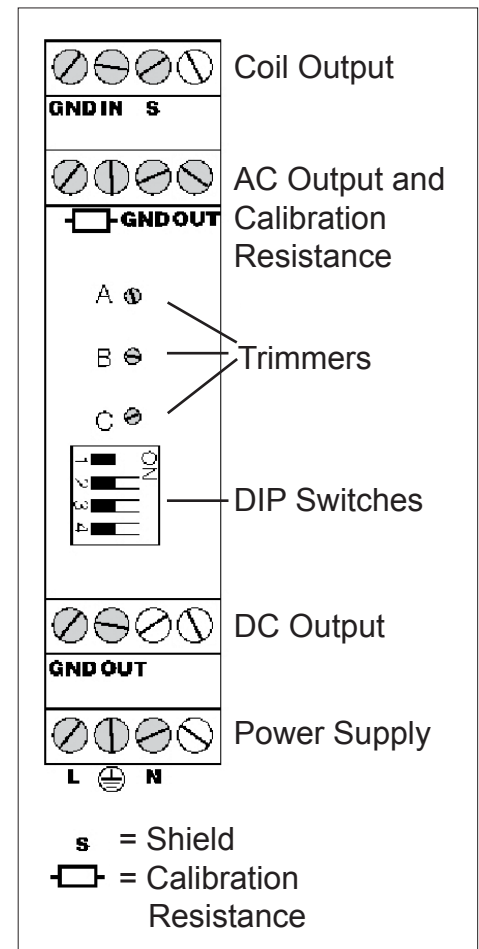

6.1 CALIBRATION RESISTANCE

For best measurement performance, insert the provided calibration resistance in the relevant terminals, fastening the screws as shown in the following pictures.

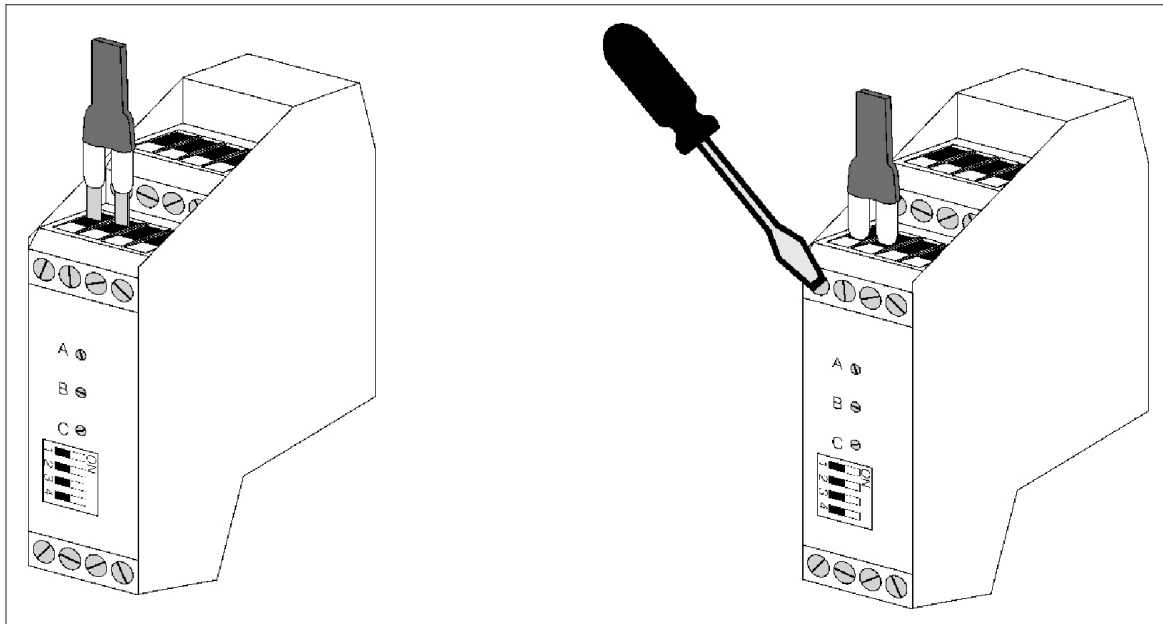

6.2 POWER SUPPLY



WARNING!

Before connecting the power supply, check if it corresponds to the value on the instrument label (85-250 V_{AC}).

The instrument has no protection fuse on the power supply, therefore the installer must protect it with a circuit breaker and an over-current protection device (315mA delayed fuse, T type).

6.3 ANALOG OUTPUTS

Two different outputs are available:

- the standard AC output representing the instantaneous value, with 3 V_{RMS} fullscale
- an **optional** DC output representing the RMS value of the measured current. The available values are: 0-20mA, 4-20mA, 0-1V or 0-10V.



WARNING!

Check if the external load parameters comply with RPS50 Technical Specifications.

7. FULLSCALE SELECTION

Dip-switches 1, 2 and 3 allow for selection of the fullscale value. The following pictures show the three possibilities for fullscale selection, according to the factory preset range (see table, section 9).

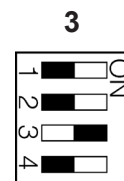
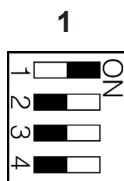

8. DC OUTPUT RESPONSE TIME SELECTION

Dip-switch 4 allows selection of the response time only for DC output (optional). The following pictures show the response time selection options.

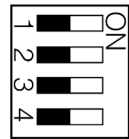

50 ms

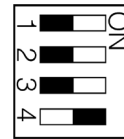

150 ms

9. CALIBRATION



WARNING!

The RPS50 is factory calibrated for best measurement performance. However, it is possible to perform a customized calibration of each measuring scale if needed.

The following picture shows the three calibration trimmers with the relevant fullscale values described in the table (fullscale values expressed in kA). Carry out the calibration following the indications relevant to your instrument's fullscale (1, 2 or 3).

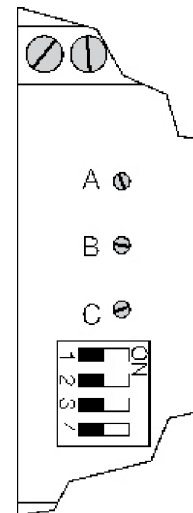

MODEL	RANGE	SWITCH SETTINGS			CALIB. POT USED
		SW1	SW2	SW3	
RPS50-10K	0.5kA	ON	OFF	OFF	A
RPS50-10K	2.5kA	OFF	ON	OFF	B
RPS50-10K	10kA	OFF	OFF	ON	C
RPS50-50K	2.5kA	ON	OFF	OFF	A
RPS50-50K	10kA	OFF	ON	OFF	B
RPS50-50K	50kA	OFF	OFF	ON	C
RPS50-250K	10kA	ON	OFF	OFF	A
RPS50-250K	50kA	OFF	ON	OFF	B
RPS50-250K	250kA	OFF	OFF	ON	C

NOTE: To select response time for dc output models only (optional):

SW4 = ON for 150ms

SW4 = OFF for 50ms

10. TECHNICAL SPECIFICATIONS

POWER SUPPLY

Rated Voltage	80-250 V _{AC} 50/60 Hz
Consumption	1.5VA max

ELECTRICAL CHARACTERISTICS

Input 1	for Rogowski coil
Input level (RMS) (1)	100mV / 1kA @ 50 Hz, other values on request
Output 1	3Vrms @ full scale, other values on request
Output 1 permissible load	>10kOhm
Output 2 (optional)	0-20mA, 4-20mA, 0-1V or 0-10V on request
Output 2 DC voltage load	100 kOhm
Output 2 DC current load	max 300 Ohm

Available fullscales (on request)	1) 0.5, 2.5, 10 kA @ 3V _{RMS}
	2) 2.5, 10, 50 kA @ 3V _{RMS}
	3) 10, 50, 250 kA @ 3V _{RMS}

Accuracy (2)	better than ±1% of full scale
--------------	-------------------------------

ENVIRONMENTAL CONDITIONS

Operating temperature	from -10°C to +50°C (from +14°F to +122°F)
Storage temperature	from -25°C to +70°C (from -13°F to +158°F)
Relative humidity	80% max. without condensation

MECHANICAL CHARACTERISTICS

Material	plastic enclosure
Protection degree	IP20
Size / Weight	115 x 100 x 23 mm / approx. 117 gr

STANDARDS COMPLIANCE

Safety	73/23/EEC and 93/68/EEC directives, EN61010.1 safety standard
EMC	89/366/EEC directive and following modifications 93/31/EEC and 93/68/EEC, EN50081-2, EN50082-2, EN61326/A1

- (1) The Rogowski coil output is proportional to the rate of change of current. The calculation formula is: $\text{Ampere}_{\text{RMS}} \times \text{Hertz} \times K \times 10^{-6}$, where K depends on manufacturing. The K value is 2 for 100mV models.
- (2) RPS50 is delivered with the specified accuracy. Moreover, the calibration of each scale is adjustable by the user to achieve the maximum accuracy in conjunction with the coil being used.
- (3) The low limit is approximate and is determined by noise effect on very low signals.

This page was intentionally left blank

This page was intentionally left blank

WARNING - The manufacturer declines all liability for any damage to people or property caused by incorrect use of this product. Subject to change without prior notice.