

DIN-RAIL MOUNTED 0.25% ACCURACY

FEATURES

- Ruggedized, Polyamide, DIN-Rail mountable
- Slim profile provides maximum utilization of space
- Field-selectable outputs ("A" models)
- UL and CUL listed

APPLICATIONS

- Ideal for use in areas with dimensional constraints
- Installations in industrial environments
- OEM measurement and control systems
- Use with external potential transformers (PTs)



**5 YEAR
WARRANTY**

Transducer output is derived from the average absolute value of the input and is calibrated as the RMS value of a sine wave input.

INPUT AC VOLTS	STANDARD OUTPUTS MODEL MVT-				
	0-1mAdc*	0-5Vdc*	0-10Vdc*	4-20mAdc	4-20mAdc
0-150	150A	150CX5	150C	150E	150E2
0-300	300A	300CX5	300C	† 300E	300E2
0-600	† 600A	† 600CX5	† 600C	† 600E	† 600E2



- * Models are self-powered from measured AC input line.
 "A" **DIP-switch-selectable 0-1mAdc, 0-5Vdc or 0-10Vdc output.**
 "E" 4-20mAdc models require 85-135Vac instrument power.
 "E2" 4-20mAdc loop powered models require 15-40Vdc loop power.
 † MVT-600x and MVT-300E models are not included in UL Listing. MVT-600x models include an external potential transformer (PT).

ORDERING INFORMATION

Example: 0-150V Input, 4-20mA Output, 115Vac Instrument Power

MVT-150E

SPECIFICATIONS

INPUT

Voltage Range..... See Table
 Frequency Range..... 60Hz nominal..... 48-65Hz
 Burden..... 150V models..... 1.0VA
 300V, 600V models..... 2.0VA
 Voltage Overload..... F.S. rating

DIELECTRIC TEST

Input/Output/Instrument Power 1500Vac

INSTRUMENT POWER

"A" / "C" / "CX5" models Self-powered
 "E" models 85-135V, 50/60Hz, 3.5VA
 "E2" models 15-40Vdc Loop Power

PHYSICAL

Connections screw terminals, use 1/8in. slotted screwdriver for access, wire size 24 to 12AWG
 Weight 150V / 300V models 0.35 lb
 600V models (with PT) 0.95 lb
 Enclosure DIN-Rail mount, Polyamide, UL 94V-2

OUTPUT

Response Time to 99% 400ms
 Field-Adjustable Span ±5%
 Loading
 "A" models 0-1mAdc 0-10kΩ
 "A" / "CX5" models . 0-5Vdc >5MΩ
 "A" / "C" models 0-10Vdc >10MΩ
 "E" models 4-20mAdc 0-500Ω
 "E2" models 4-20mAdc @ 24Vdc 0-600Ω

ACCURACY

Linearity/Setpoint/Repeatability. ±0.25% F.S. @ 60Hz
 (10%-100% of input range)
 Output Ripple ≤1.0% F.S.

TEMPERATURE

Operating Range and Effect:
 "A"/"C"/"CX5" -20 to +65°C ±1.0% Rdg.
 "E" models -20 to +40°C ... ±1.0% Rdg., ±0.02mA
 "E2" models -20 to +65°C ... ±1.0% Rdg., ±0.02mA

(Consult factory for availability of DIN-rail sections)



SELF-POWERED "A" / "C" / "CX5" MODELS

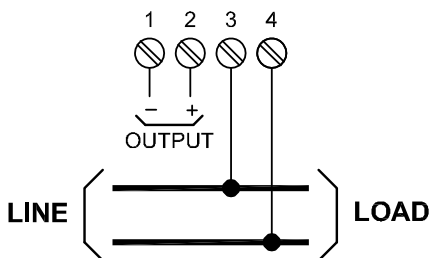

150 & 300Vac MODELS

PTs: CONNECT AS SHOWN IN 600V DIAGRAM.

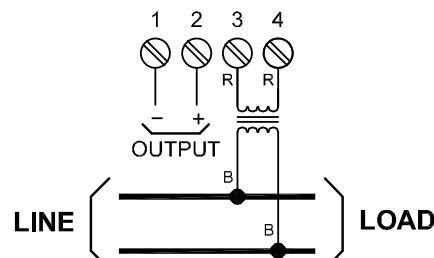
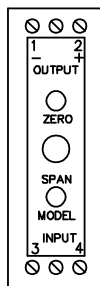

600Vac MODELS

(PT SUPPLIED WITH UNIT)

LOOP-POWERED "E2" MODELS

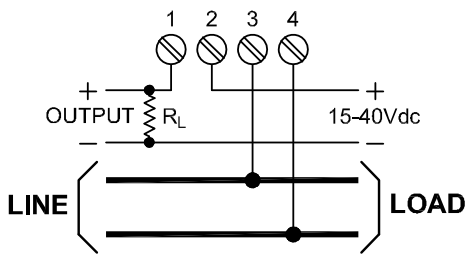

150 & 300Vac MODELS

PTs: CONNECT AS SHOWN IN 600V DIAGRAM.

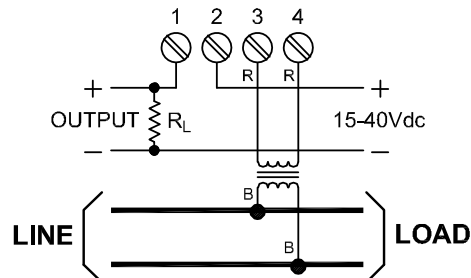
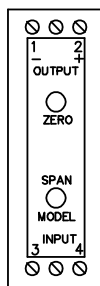

600Vac MODELS (PT SUPPLIED WITH UNIT)

"E" MODELS

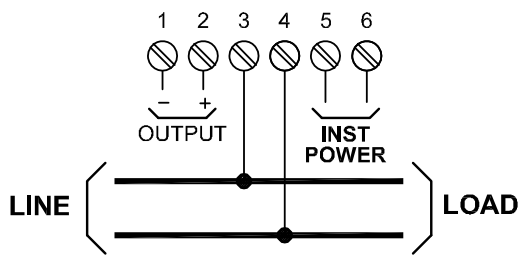

150 & 300Vac MODELS

* AC INSTRUMENT POWER, TERMINALS 5, 6

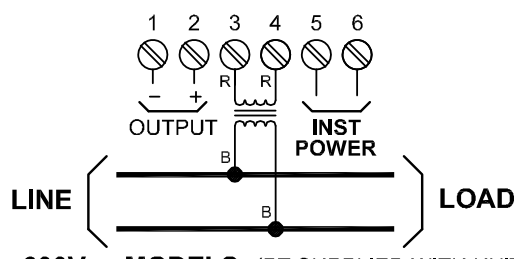
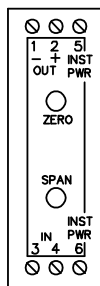

600Vac MODELS (PT SUPPLIED WITH UNIT)

* AC INSTRUMENT POWER, TERMINALS 5, 6

Mounting Dimensions

UNIT CAN BE MOUNTED ON:
STANDARD 35MM TOP-HAT DIN-RAIL (DIN3) PER EN 50022 OR STANDARD 32MM "G" DIN-RAIL (DIN1) PER EN 50035.

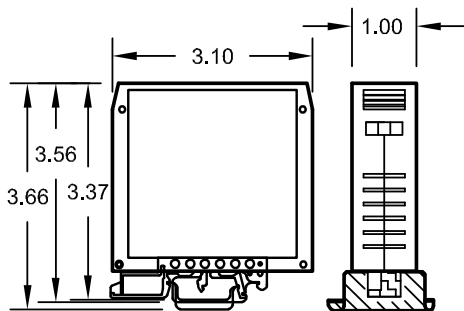

ALL DIMENSIONS IN INCHES.

Output Selections, "A" Models

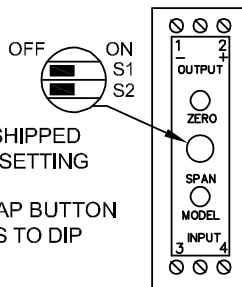

UNITS ARE SHIPPED WITH 0-1mA SETTING

REMOVE SNAP BUTTON FOR ACCESS TO DIP SWITCHES

OUTPUT	SWITCH POS. 1	SWITCH POS. 2
0-1mA	OFF	OFF
0-5V	ON	ON
0-10V	ON	OFF

PT Dimensions

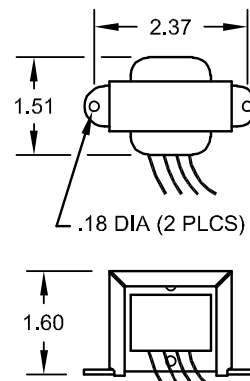

ALL DIMENSIONS IN INCHES.

Dwg# 0902-00862-B Rev-C

INSTALLATION INSTRUCTIONS

1. Installation should be performed by qualified electricians only!
2. Electrical service must be disconnected before making any electrical connections!
3. Branch circuit protection is required to be provided in accordance with the National and Local codes of the inspection authority.
4. Route wires as required and secure to terminals per connection diagram on this sheet and on the unit.

OPERATING INSTRUCTIONS

1. This unit is intended for indoor use at altitudes up to 2000 meters.
2. Transient overvoltages according to Installation Category (overvoltage) II, Pollution Degree 2.
3. The output signal is intended to be "Not accessible to the user." To prevent contact with live circuits, the transducer must be mounted in an enclosure that requires the use of a tool for access.
4. If cleaning of the exterior surface is necessary, de-energize all services of supply (both measuring and instrument power circuits) and brush with a soft brush or blow off with low-pressure air. Use appropriate eye protection. Not suitable for hose-down cleaning.
5. Maximum relative humidity 80 percent for temperatures up to 31°C decreasing linearly to 50 percent relative humidity at 40°C.
6. Maximum operating temperature range is -20 to +65°C (-20 to +40°C for "E" suffix models).

WARRANTY STATEMENT

Ohio Semitronics Inc. warrants this unit to be free of defects in material and workmanship for a period of five years from date of shipment. This unit must not be used in any manner other than as specified in this document.